

HAILIAN MARINE

Product Catalogue



www.hailianmarine.com

HAILIAN MARINE

ABOUT US

Hailian marine is a manufacturer & wholesaler for marine safety spares and offshore equipment and tools. In our 2200 m² warehouse we store our extensive range of products from firefighting equipment and life saving, tools to safety items.



Our team is made up by excellent business personnel, product managers, product engineers and QA, all of them have rich experience. Our company holds the operation benchmark at high quality, high-efficient service, practical management, forward business concepts, and very competitive prices to provide faultless Supply Chain service to our clients.

We promise that we will provide you the high quality products with the best prices. Our team will do our utmost to serve you and to guarantee the most competitive price for the products you purchase from us. Your satisfaction is our mission!

Please send questions or enquiries to: sales@hailianmarine.com
You will receive a reply within one day for the standard items.

Fire Fighting Appliances

1	Self-Contained Breathing Apparatus	- 5 -
2	SCBA Tester (POSICHEK)	- 5 -
3	Fire Extinguishers (CCS and EC MED), Spares, Bracket, Cover	- 6 -
4	Fire Extinguisher Filling Machine	- 7 -
5	Portable Foam Applicator	- 8 -
6	Marine Fire Hose, Spanners, Nozzle, Coupling, Adaptor, Fire Hydrant Valve	- 9-11 -
7	Fireman suit (Aluminized Heat-insulation suit, fire proximity suit)	- 12 -
8	Explosion proof Lamp (Torch, hand lamp)	- 12 -
9	Fireproof Safe Line	- 13 -
10	Fireman Safety Belt and Pouch	- 13 -
11	Fire Axe	- 14 -
12	Fiber Glass Reinforced Products (Customized sizes acceptable)	- 15 -

Life Saving Appliances

1	EEBD (Emergency Escape Breathing Device)	- 16 -
2	Insulated Immersion Suits (Survival Suits)	- 16 -
3	Lifejackets (EC-MED, CCS Certificated)	- 17 -
4	Fishing Vests	- 18 -
5	3-Piece Work Vest (for oil rig)	- 18 -
6	Inflatable Lifejackets	- 18 -
7	Lifejacket lights	- 19 -
8	Life Buoy and Accessories	- 20 -
9	Inflatable Life Raft (EC-MED, ABS, LR, CCS Certificated) and Accessories	- 21-23 -
10	Stretchers	- 24 -
11	Pyrotechnics	- 25 -
12	Fire Blanket	- 25-26 -

Personal protective Appliances

1	Chemical Protective Suits	- 27 -
2	Fall Protection	- 27 -
3	Body Protection	- 28 -

Deck Equipment

1	Jacob Ladder	- 29 -
2	Pilot ladder and Embarkation ladder in solid wood or aluminum steps.	- 29-30 -
3	Aluminum Alloy Gangway, Gangway Ladder, Bulwark Ladder	- 31 -
4	Gangway Net, Cargo Net (232151, 232152)	- 32 -
5	Personnel Transfer Net	- 32 -
6	Scramble Net with or without Spreader	- 33 -
7	Helideck or Helipad Safety Net	- 33 -
8	Rope Netted Fenders	- 33 -
9	Scupper Plug (Brass)	- 34 -
10	Air Hose Couplings	- 35 -
11	Oil Spill response Containers (IMPA 232516 232531 232532)	- 35 -

Nautical Equipment

1	Signal Bells and Gongs	- 36 -
2	Day Signals (Shapes)	- 36 -
3	Marine Clocks	- 37 -
4	Marine Aneroid Barometer, Dial Thermo-Hygrometers, Barometer / Thermometer	- 37 -
5	Clinometer Dial type and Fan type.	- 38 -
6	Azimuth Circle	- 38 -
7	Nautical Sextants	- 38 -
8	Binoculars IMPA 370342-45	- 38 -
9	Parallel Rulers, Nautical Triangles (Inoue Type, Kent Type), Gauging Tape	- 39 -
10	Chart Dividers and Chart Room compasses	- 39 -
11	Flag Hooks, blocks, flag rope	- 40 -
12	Windsocks	- 40 -
13	Navigation Signal Light, Search Light, Flood Light, Spot Light, Fluorescent Light.	- 41 -
14	Recording Paper for Navigational Equipment (Various types)	- 42 -

Tools and others

1	Pneumatic Jet Chisels (JEX) /Hammer and spares.	- 43 -
2	Electric or Pneumatic Blower, Portable Ventilation Fans	- 43 -
3	Deck Scalers, Scaling Machine	- 44 -
4	Pneumatic Diaphragm Pumps	- 45 -
5	15ppm Oily Water Separator (Bilge Separator)	- 45 -
6	SWCM Sewage Treatment Plant for Marine and Offshore Platform	- 46 -
7	Miscellaneous	- 47-48 -



Discription
Self-Contained Breathing Apparatus

Standards: SOLAS 1974 as amended, MSC.36 (63)-(1994 HSC code) 7, IMO Res. MSC.97 (73)-(2000 HSC code) 7 and IMO Res. MSC.98. (73) - (FSS code) 3, EN 136 and EN 137.

Certification: EC-MED by DNV.GL/KRH and CCS
Brands Available: Huayan, Fangzhan, Dongfang, Haizhou, Rongsheng etc.

Component: Full face mask, Demand valve, Cylinder, Pressure gauge and Warning Whistle, Pressure reduce valve, Back support, Plastic carrying suitcase.



Model	Working pressure	Volume (L)	Air Deposit (L)	Duration Period (Min)	Alarm Pressure (MPa)	Weight (Kg)	Cylinder Material	Packing
	(MPa)							(mm)
RHZK5/30	30	5	1500	40-50	4~6	≤12	Steel	755×460×290
RHZK6/30	30	6	1800	50-60	4~6	≤14	Steel	755×460×290
RHZKF6.8/30	30	6.8	2040	50-60	4~6	≤10	Al. lined Carbon fiber composite	755×460×290



Discription
SCBA Tester (POSICHEK)

The HX-II is a computerized automatic test bench used to evaluate the performance of self-contained breathing apparatus and other types of respiratory protective equipment.

During the test process, the user operate the computer to control the artificial lung. The artificial lung simulates different breathing states to test the SCBA dynamically, and the HX-II will decide whether the SCBA pass the test automatically. The dynamic breathing resistance graph and figures will be shown on the screen. You can print the reports or save the reports in the computer for further using. Fire brigades, testing institutions and manufacturers of breathing apparatus can use this equipment to test their breathing apparatuses.



Discription

Fire Extinguisher (Powder)

Fire Extinguisher in Portable Cylinders or Trolley, Stored Pressure or Gas Cartridge type, as well as spares. Only delivered as DG Cargo.



Discription

Fire Extinguisher (CO2)

Fire Extinguisher in Portable Cylinders or Trolley, Stored Pressure or Gas Cartridge type, as well as spares. Only delivered as DG Cargo.



Discription

Fire Extinguisher (Foam)

Fire Extinguisher in Portable Cylinders or Trolley, Stored Pressure or Gas Cartridge type, as well as spares. Only delivered as DG Cargo.



Discription

Fire Extinguisher Bracket

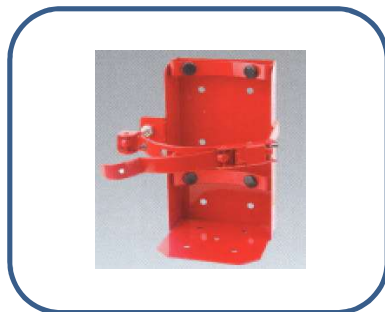

Discription

Fire Extinguisher Bracket



Discription

Fire Extinguisher Cover



Discription

Fire Extinguisher Filling Machine



Discription

Fire Extinguisher Filling Machine



Discription

Fire Extinguisher Filling Machine



Discription

Fire Extinguisher Filling Machine



Discription

Portable Foam Applicator

Approval: SOLAS DNV, SOLAS GL, CCS, different types of connections on request.



Discription

Portable Foam Applicator

Approval: SOLAS DNV, SOLAS GL, CCS, different types of connections on request.



Discription

Portable Foam Applicator

Approval: SOLAS DNV, SOLAS GL, CCS, different types of connections on request.



Discription

Fire Hose

Fire hoses with CCS and MED approval (Natural Rubber or Synthetic EPDM rubber lining, double side synthetic rubber).



Discription

Spanners



Discription

Fire Hose Nozzles



Discription

3 -position shut/spray/jet Nozzles



Discription

Fire Hose coupling

Storz



Description

Fire Hose coupling

John Morris



Description

Fire Hose coupling

Nakajima



Description

Fire Hose coupling

Machino



Description

Fire Hose coupling

ANSI Pin



Description

Fire Hose coupling

French, NOR, Barcelona, Swedish SMS, Italian type etc.



Discription
end caps



Discription
various types of Fire Hose adaptors



Discription
International shore connection

together with various types of adaptors



Discription
hydrant valves



Discription

**Fireman suit (Aluminized Heat-insulation suit, fire proximity suit)
MED Approved**

The MED approved fire proximity suit are made to EN 469:2005 or ISO 15538:2001, with jacket, trousers, HARVIK 9687L boots, PAB Fire HT04 helmet (EN443) and leather gloves (EN659), all MED approved.



Discription

**Fireman suit (Aluminized Heat-insulation suit, fire proximity suit)
CCS Approved with boots & helmets**

The SOLAS CCS approved fireman suit with consists of jacket, pants, gloves, hood, helmet, boots and boot cover.



Discription

**Explosion proof Lamp (Torch, hand lamp)
FBSD(IEC Ex, CCS)
Brand: Huayan**



Discription

**Explosion proof Lamp (Torch, hand lamp)
EX-250R (L)(ATEX)
Rechargeable**



Discription

**Explosion proof Lamp (Torch, hand lamp)
4DBC-E(IEC Ex, CCS)
Jiangsu Huayan**



Discription
Explosion proof Lamp (Torch, hand lamp)
DF/JZ-6 (CCS)
Dongfang/Jiangbo



Discription
Fireproof Safe Line

EC MED Approval by GL (Also CCS approved)



Discription
Fireproof Safe Line

CCS Approval



Discription
Fireman Safety Belt and Pouch

Fabric type



Discription
Fireman Safety Belt and Pouch

Fabric type



Discription
Fireman Safety Belt and Pouch

Leather type



Discription
Fire Axe with Insulated short Handle

With SGS Test Report (20KV)



Discription

Fire Axe

Pick head Fire Axe with Wooden Long Handle



Discription

Fire Axe

Pick head Fire Axe with GRP Long Handle



Discription

Fiber Glass Reinforced Products (Customized sizes acceptable)

GRP made fire hose cabinet (box), fireman Outfit box, Lifejacket Storage Box, EEBD box, Safe Plan Canister, Foam Applicator box etc. Customized sizes are acceptable.



Discription

Fiber Glass Reinforced Products (Customized sizes acceptable)

GRP made fire hose cabinet (box), fireman Outfit box, Lifejacket Storage Box, EEBD box, Safe Plan Canister, Foam Applicator box etc. Customized sizes are acceptable.



Discription

Fiber Glass Reinforced Products (Customized sizes acceptable)

GRP made fire hose cabinet (box), fireman Outfit box, Lifejacket Storage Box, EEBD box, Safe Plan Canister, Foam Applicator box etc. Customized sizes are acceptable.



Discription

Hose binding machine



Discription

Portable Hose binding machine



Discription
EEBD (Emergency Escape Breathing Device)

TH-15; THHZ15

Specified Standards: SOLAS 1974 as amended, IMO MSC.98 (73), IMO MSC/Circ.849, EN 1146(2005) and ISO 23269-1(2008).

The EEBD is composed of compressed air cylinder, pressure reducing valve, pressure gauge, air hose, face hood, cylinder bag.

EC-MED and CCS Approved. Brands: Fangzhan, Huayan, Haizhou,Dongfang.



Type	Cylinder Material	Cylinder Volume (L)	Working Pressure (Mpa)	Air Stored (L)	Airflow (L/min)	Duration Period (Min)	Weight
10 Minutes	Steel Alloy	2.2	21	>400	>=35	>= 10	6 Kg
15 Minutes	Steel Alloy	3.2	21	>600	>=35	>=15	8 Kg
15 Minutes	Carbon fiber composite cylinder	3L	21	>600	>=35	>=15	5 Kg



Discription
Insulated Immersion Suits (Survival Suits)

Inspection Standards:
SOLAS 74/78 as amended Reg. III/4, III/7, III/22, III/32, III/34, X/3
LSA Code I, II, as amended by MSC.207(81), MSC.218(82)
HSC Code 1994 MSC.36(63) and 2000 HSC Code MSC.97(73) 8
IMO Resolution MSC.81(70), MSC.226(82)

Certifications: MED by DNV.GL, CCS
Brands available: Huayan, Xingtai, Jiangbo, Fangzhan, Haixing, YEAN, Ronggui etc.

Technical Information:
Buoyancy: Min147N
Cover Material: PU & Polyester compound or Neoprene Fabric
Inside Material: polyethylene foam, Aluminum foil, Taffeta seam together.
Accessories: Whistle, lifejacket light (MED approved), grabbing rope(buddy line).
Production tests are conducted for each unit in accordance with IMO Res. MSC.81 (70).





Description
Insulated Immersion Suits (Survival Suits)

Infant and Child Immersion Suits are Available with Factory Certification!



Description
Lifejackets (EC-MED, CCS Certificated)

Brands available: Huayan, Jiangbo, Fangzhan, Haixing, Xingtai, YEAN, Ronggui etc.



Description
Lifejackets (EC-MED, CCS Certificated)

Brands available: Huayan, Jiangbo, Fangzhan, Haixing, Xingtai, YEAN, Ronggui etc.



Description
Lifejackets (EC-MED, CCS Certificated)

Brands available: Huayan, Jiangbo, Fangzhan, Haixing, Xingtai, YEAN, Ronggui etc.



Description
Lifejackets (EC-MED, CCS Certificated)

Brands available: Huayan, Jiangbo, Fangzhan, Haixing, Xingtai, YEAN, Ronggui etc.



Discription
Fishing Vests



Discription
Fishing Vests



Discription
Fishing Vests



Discription
3-Piece Work Vest (for oil rig)

Buoyancy: Min 75N. Made with closed-cell foam imported from Taiwan. Vinyl dipped coated, Orange color. 3 SOLAS tapes, Size 5cm x 10cm. 2 on the front, 1 on the rear. Best alternative to the Sea Horse WV-10!



Discription
Inflatable Lifejackets (MED Approval by GL, CE approval by GL)
EC MED SOLAS(Twin-Chamber)

SOLAS (EC MED) approved inflatable lifejacket with twin-chamber just introduced, contact us for more details!



Description

**Inflatable Lifejackets (MED Approval by GL, CE approval by GL)
Available: 150N and 275N, single chamber**

CE, Before Inflation

TECHNICAL PARAMETERS

1. Weight \leq 1.0 kg.
2. Buoyancy \geq 150 N
3. Angle in water:
face plane angle \geq 40° ,
trunk angle \geq 30° ;
4. Freeboard: \geq 120mm ;
5. Inflation time \leq 5s
6. float duration \geq 24h
7. Buoyancy loss after 24h \leq 5%
8. CO2 Weight: 33g
9. Ambient temperature for use:
-30° C ~ +65° C
- 10 . Validity: 3 years



CE, After Inflation



Description

**Life Jacket Light (EC MED and CCS Approval)
LNK-NJ-03A1
LNK-LJ-02C1**

Made by the China OEM factory of ACR HL-3



Description

**Life Jacket Light (EC MED and CCS Approval)
DFYD-L-B
DFYD-C**



Description

Whistle



Discription

Life Buoy and Accessories (EC and CCS Certification)

EC MED and CCS approved.

brand Huayan, Xingtai, Lonako

国际编码 IMPA code	工厂编码 Factory code	型号 Type	外形尺寸 Size (mm)			重量 Weight	浮力 Buoyancy	认可 Approvals
			外径 Outer diameter	内径 Inner diameter	厚(高) Thickness			
33 01 51	2001001031	DY5555	713 ⁺¹⁰ ₋₀	445 ⁺¹⁰ ₋₅	95 ~ 115	≥2.5kg	≥14.5kg	CCS/EC
33 01 51	2001001034	DY5555-4	750 ⁺¹⁰ ₋₀	468 ⁺¹⁰ ₋₅	95 ~ 115	≥4.3kg		



Discription

Life Buoy light

EC MED and CCS approved.

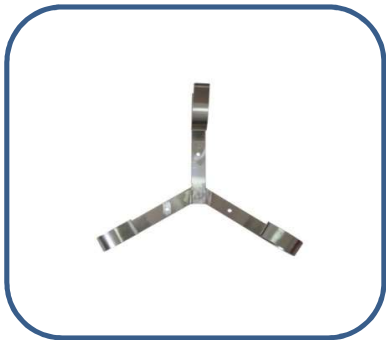

Discription

Life Buoy Bracket



Discription

Encapsulated heaving line 8mm*30m for Lifebuoy ring

Heaving line 8mm*30m for Lifebuoy ring



Discription

Life Buoy Box



Discription
Life Buoy



Discription
Inflatable Life Raft (EC-MED, ABS, LR, CCS Certificated)

Approved by CCS, DNV.GL, ABS etc. It can be used in the ships engaged on international voyages



Discription
Inflatable Life Raft (EC-MED, ABS, LR, CCS Certificated)

Approved by CCS, DNV.GL, ABS etc. It can be used in the ships engaged on international voyages



Discription
Life Raft Accessories

Bracket



Discription
Life Raft Accessories



SENHOUSE Slip Hook
Hydrostatic Release Unit



Discription
Life Raft Accessories

**External & Internal light for life raft
search light**



Discription
Life Raft Accessories

**can openers
jack knives**



Discription
Life Raft Accessories

fishing tackles



Discription
Life Raft Accessories

**manual bilge pump
bailers**



Discription
Life Raft Accessories

compasses

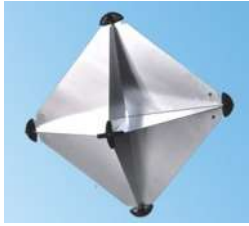

Discription
Life Raft Accessories

Radar reflectors



Discription
Life Raft Accessories

paddles



Discription
Life Raft Accessories

dippers



Discription
Life Raft Accessories

Safety belt



Discription
Life Raft Accessories

rescue quoits



Description

Life Raft Accessories

We also provide other Life Raft Accessories like hatchets, sponges, buckets, sea anchor, oil cans, drinking cups, whistles, signaling typhoons, survival manuals, daylight signal mirrors, rowlocks etc

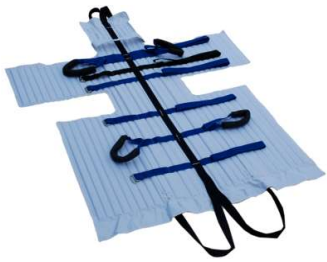

Description

Neil Robertson Stretchers

Suitable for use in marine, mining, construction and field work applications



Description

Basket Type Stretcher, complete with sling

Suitable for use in marine, mining, construction and field work applications



Description

Pyrotechnics

Rocket Parachute Red Flare, Red Hand Flare, Orange Buoyant Smoke Signal, Lifebuoy Self-Igniting Light and Self-Activating Smoke Signal, Self-contained Line Throwing Unit, Marine Line-throwing Appliance. All In compliance with SOLAS 1974/1996 and MSC.81 (70). EC-MED\CCS Approved.



Note: To purchase Pyrotechnics, you should have the business license for explosive goods from local authorities and proper storing facilities. We only accept order via FCL for pyrotechnics



Discription
Pyrotechnics



Discription
Pyrotechnics



Discription
Fire Blanket
Plastic Box Packed

Size: 1.2m x 1.8m or as per required, according to Standard: EN1869:1997



Discription
Fire Blanket
Bag Packed

Size: 1.2m x 1.8m or as per required, according to Standard: EN1869:1997



Discription
Fire Blanket
Canister Packed

Size: 1.2m x 1.8m or as per required, according to Standard: EN1869:1997



Discription
Smoke Hood



Discription
Lifeboat battery charger



Description
Chemical Protective Suits

RFH-01
Spray Tight
CCS Approval



Description
Chemical Protective Suits

RFH-02
Gas Tight
CCS Approval



Description
Chemical Protective Suits

Splash 600 Trelchem
Spray Tight
SOLAS GL Approval



Description

Chemprotector
Gas Tight EN943-1
SOLAS GL Approval



Description

Safety belt



Discription
Eyewash station



Discription
Jacob Ladder

Rung made with round solid wood (Diameter: 38mm, L=470cm)
Side Rope: 20mm Nylon or Manila Rope.
Supply with Manufacturer's Certification.



Discription

Pilot rope ladder and Embarkation rope ladder
in solid wood or aluminum steps

Material: Aluminum Alloy or Rigid Solid Wood,
with bottom 4 rubber steps.

Approval: EC MED, CCS to SOLAS

Standard: SOLAS 1974/1996, MSC 48 (66),
MSC 81(70), ISO 5489:2008, ISO 799(2004)



Discription
wood steps



Discription
Spares



Discription
Details for product



Discription
Aluminum clamps



Discription
Yellow Magnetic



Discription
Yellow Magnetic



Discription
Aluminum steps



Discription
Ladder for lifeboat



Discription
Aluminum Alloy Gangway, Gangway Ladder, Bulwark Ladder



Fitted with Aluminum Stanchion Sockets, removable aluminum Pipe Stanchions and removable PP Rope Handrails, the Gangway has the deck plate with the bowed truss construction, and two wheels on one end. The Gangways of this type can be manufactured up to 15 meters in length. We also provided flat beam type Gangway and heavy duty gang way with steps.



Discription
Aluminum Alloy Gangway, Gangway Ladder, Bulwark Ladder



Discription
Aluminum Alloy Gangway, Gangway Ladder, Bulwark Ladder



Description

Aluminum Alloy Gangway, Gangway Ladder, Bulwark Ladder

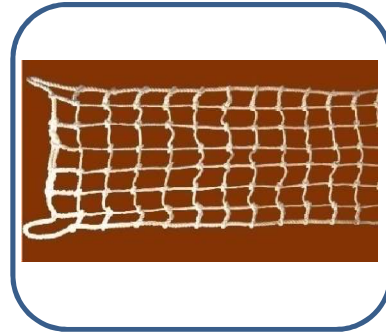

Description

Gangway Net, Cargo Net (232151, 232152)

Gangway Safety net size and material (rim rope, mesh rope in PP, PE or Nylon) as per customer requirement



Description

Gangway Net, Cargo Net (232151, 232152)



Description

Personnel Transfer Net

Certification: CE Approval by HPI, ABS

Personnel Transfer Net is used to quickly and effectively transport personnel on and off of platforms. Our products are made of a sturdy and very durable material that encompasses the rider to protect them from falling objects and any side impact that may occur. All models are CE approved to provide safety and give the rider confidence while in transit.

Models:

Folding type: HY-4, HY-6, HY-10 and HY-18 for 4, 6, 10, 18 persons respectively.

Persons stand outside one the buoyant ring around the net.

Standing type: HYL-10 for 10 persons. Persons stand inside the net.





Discription

Scramble Net with or without Spreader

Scramble Net made with Nylon, PE or PP rope. Diameter 18cm or 20 cm. Mesh size: 18cm or 20 cm, with or without spreader or other accessories. Customized sizes are accepted.



Discription

Scramble Net with or without Spreader



Discription

Helideck or Helipad Safety Net

Helideck nets are used on the offshore helicopter landing decks, oil rigs and platforms where more friction and support is required. The purpose of these nets is to prevent the helicopter from rolling and pitching off the helipads.

Helideck nets are generally made of tested quality polypropylene rope and fabricated in tucked style. We also supply manila and sisal rope helideck nets, or as per customers requirement



Discription

Rope Netted Fenders



Discription

Rope Netted Fenders



Discription
MONKEY FIST BALL



Discription
Scupper Plug (Brass)
Made from brass and oil resistant rubber.
(Stainless or Nylon Scupper Plug are on request)
Brass plate thickness: 3mm or 5mm

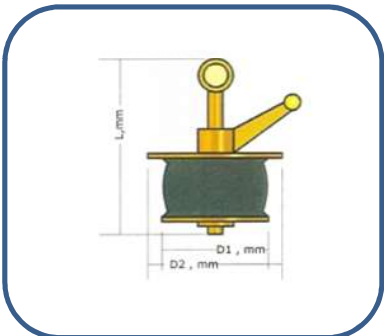

Code	Model	Dimensions mm			Applicable Drain Pipe Size
		D1	D2	L	
232481	BSP-1	45	65	145	2" Sch-80
232482	BSP-2	52	75	145	2" SGP, Sch-40, 3" SGP, Sch-40, 60,80
232483	BSP-3	65	85	160	2 1/2" SGP, Sch-40, 3" SGP, Sch-40, 60,80
232484	BSP-4	85	110	160	4" Sch-60
232485	BSP-5	90	115	160	4" SGP, Sch-40, 80, 5" Sch-60
232486	BSP-6	110	135	160	5" SGP, Sch-40, 80, 6" Sch-60
232487	BSP-7	135	160	160	6" SGP, Sch-40, 80
232488	BSP-8	165	200	170	8" STPG-38, Sch-80, 160



Discription
Air Hose Couplings

Lock Type, Universal Type, Cast Bronze Type, Brass Screw Type, Branch Piping Coupler



Discription
Air Hose Couplings



Discription
Air Hose Couplings

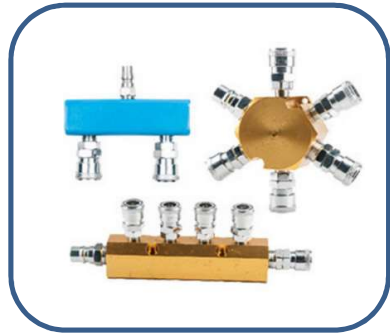

Discription
Air Hose Couplings



Discription
Air Hose Couplings



Discription
Air Hose Couplings



Discription
Oil Spill response Containers (IMPA 232516 232531 232532)



Discription
Signal Bells

Specification: International Marine Anti-collision Regulation (1972), 1996 Amendments to the SOLAS1974



Discription
Gongs

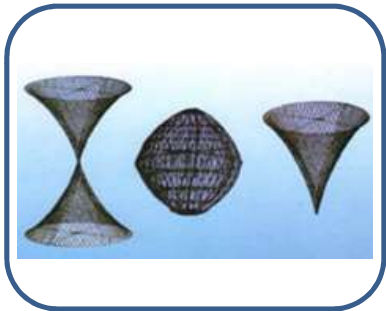

Discription
Day Signals (Shapes)

Specifications
Product Inspection Standard: International Marine Anti-collision Regulation (1972) and 1996 Amendments to the SOLAS1974.

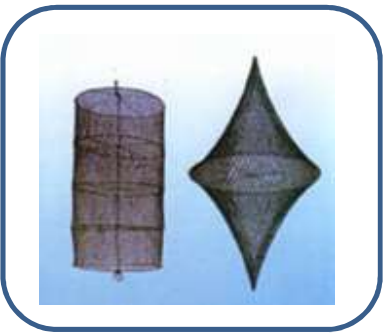

Discription
Day Signals (Shapes)

Shapes Available: Ball, Cylindrical, Conical, Double Conical, Diamond



Discription
Marine Clocks



Discription
Marine Clocks



Discription
Marine Clocks



Discription
Marine Clocks



Discription
Marine Aneroid Barometer, Dial Thermo-Hygrometers, Barometer / Thermometer



Discription
Marine Aneroid Barometer, Dial Thermo-Hygrometers, Barometer / Thermometer



Discription
Clinometer Dial type



Discription
Clinometer Fan type



Discription
Azimuth Circle
All made with brass, powder painted, packed in aluminum suitcase

Type	Inside dia.	Outside dia.	Net weight
GFC-165	226mm	239mm	1.5kg
GFC-190	247mm	260mm	1.6kg
GFC-165A	247mm	260mm	1.7kg



Discription
Nautical Sextants
IMPA 370332 Safely Packed in Wooden box



Discription
Binoculars IMPA 370342-45

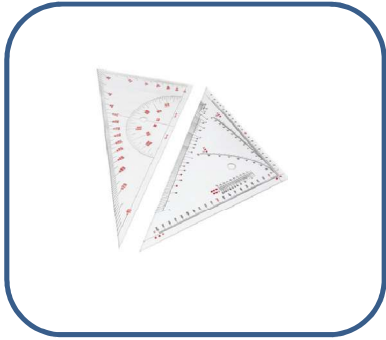

Discription

Nautical Triangles (Inoue Type, Kent Type)



Discription

Parallel Rulers



Discription

Gauging Tape



Discription

Chart Dividers and Chart Room compasses



Discription

Chart Dividers and Chart Room compasses



Discription
Flag Hooks, blocks

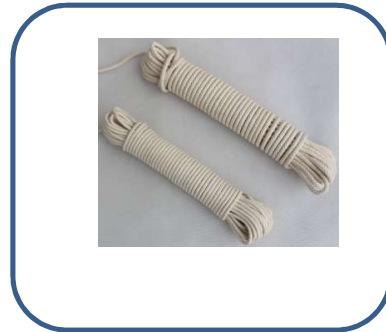

Discription
flag rope



Discription
Windsocks
Windsock with stainless steel frame, with or without reflective tapes



Discription
Search Light

All types of lamps/lights that used on marine and offshore. We are agent of Haixing Maritime, China top manufacturer of marine & offshore lamps and lights



Discription
Search Light



Discription
Search Light



Discription
Navigation Signal Light



Discription
Navigation Signal Light



Discription
Flood Light



Discription
Spot Light



Discription
Fluorescent Light.



Discription
Fluorescent Light.



Discription
Recording Paper for Navigational Equipment (Various types)

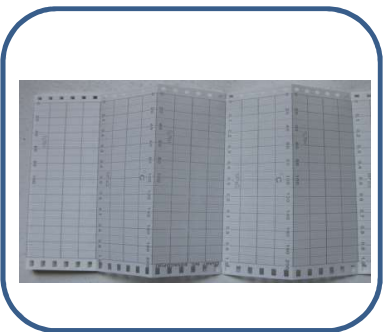

Discription
Recording Paper for Navigational Equipment (Various types)



Discription

Pneumatic Jet Chisels (JEX) /Hammer and spares

JT-20, JC-16, JEX-24, JEX-28 and spares such as needles, needle support



Discription

Pneumatic Jet Chisels (JEX) /Hammer and spares

JT-20, JC-16, JEX-24, JEX-28 and spares such as needles, needle support



Discription

Pneumatic Jet Chisels (JEX) /Hammer and spares

JT-20, JC-16, JEX-24, JEX-28 and spares such as needles, needle support



Discription

Electric or Pneumatic Blower, Portable Ventilation Fans



Discription

Electric or Pneumatic Blower, Portable Ventilation Fans



Discription
Electric or Pneumatic Blower, Portable Ventilation Fans



Discription
Electric or Pneumatic Blower, Portable Ventilation Fans



Discription
Deck Scalers, Scaling Machine



Discription
Deck Scalers, Scaling Machine



Discription
Deck Scalers, Scaling Machine



Discription
Deck Scalers, Scaling Machine



Discription
Pneumatic Diaphragm Pumps

WL25 WL-40



Discription
Pneumatic Diaphragm Pumps

WL-50 WL-80



Discription
Marine Environment Protection Machine



Discription
Marine Environment Protection Machine



Discription

SWCM Sewage Treatment Plant for Marine and Offshore Platform

This plant is meet the effluent standards of IMO MEPC.159(55).

CCS and MED Wheel Mark Approved.

Different capacities are available: from 10 to 400 persons on board.



Discription

HAZARD WARNING REFLECTIVE



Discription

Retro Reflective Tape



Discription

Tape



Discription

ANTI-SPLASHING TAPE



Discription
ANTI-SPLASHING TAPE

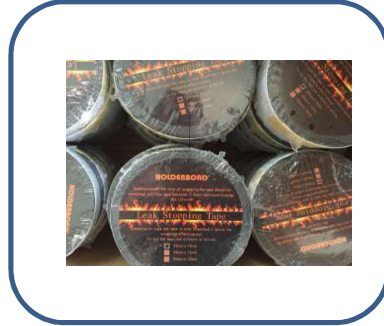

Discription
TAPE



Discription
Tape



Discription
letter

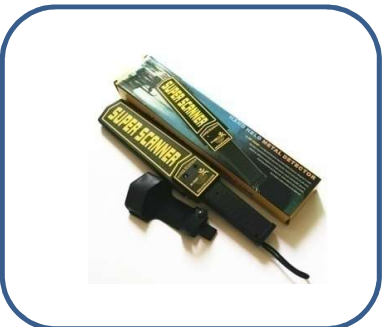

Discription
Metal detector



Discription
Sounding lead



Discription
Others against customers demand

HAILIAN MARINE

HAILIAN MARINE

Address: No. 1288 Chengbei Road, Kunshan City,
Jiangsu Province, China. 215300

Tel: +86 512 5771 8617

Fax: +86 512 5790 7599

Mobile: +86 180 5189 8617

E-mail: sales@hailianmarine.com

www.hailianmarine.com

Extensive product range

High quality and low price level

Worldwide delivery service

Fast delivery due to in-house logistics

24/7 Quotations respond

2200 m2 warehouse